

Ascent/Ascent Wings

Low ballast tilt mounting system for PV Installation on flat roofs

The PVezRack® Ascent is a low ballast, south/north, east-west facing solution without rails for PV installation on flat roofs. With the special design and a tilt angle of 10° and 15°, Ascent is suitable for pv module length up to 2350mm, width up to 1134mm, height from 28mm to 46mm.

Main Benefits

Ballast Optimised

Ballast reduction through aerodynamic Optimised construction. Also tested in boundary layer wind tunnel by the independent wind tunnel test agency, to achieve optimum ventilation for maximum energy output.

Easy and Quick Installation

With the click connections between Legs and Bases, no tools are used during the Legs and Bases assembly, significantly reduce installation labor. The storage space is greatly reduced due to the innovative Rear Leg Extension, thereby saving the cost of warehouse management.

Compatibility

Available with a module widths up to 1134mm, PVezRack® Ascent offers flexible solutions and suitable for all framed PV panels with height from 28 to 46mm. Power optimizer, micro inverter can be easily accommodated.

**12 Year
Warranty**

Commercial

Residential

Ascent

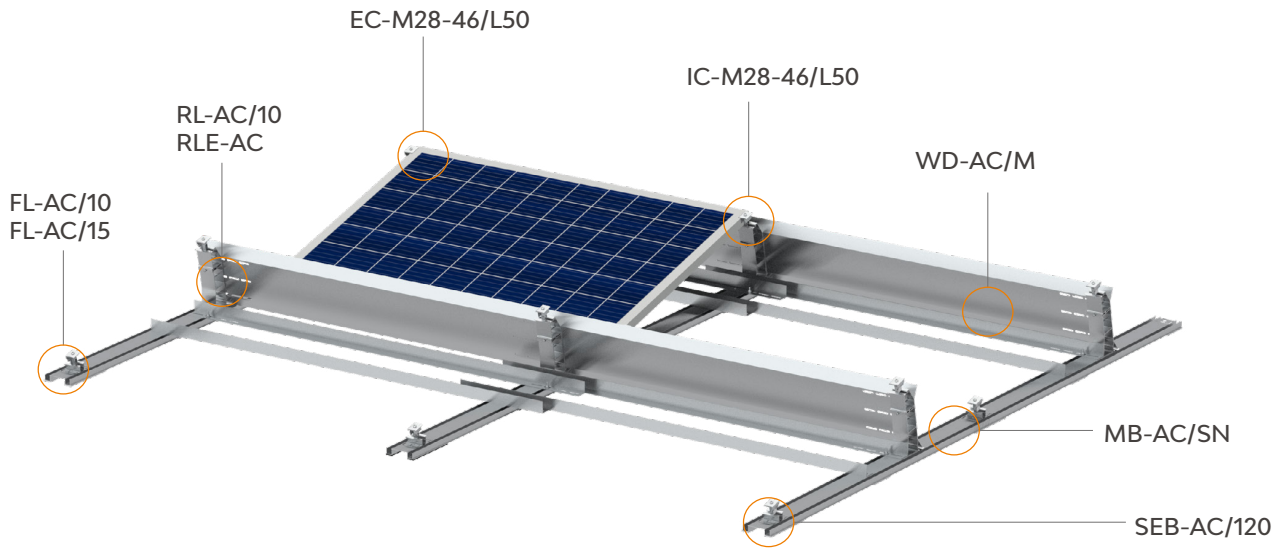



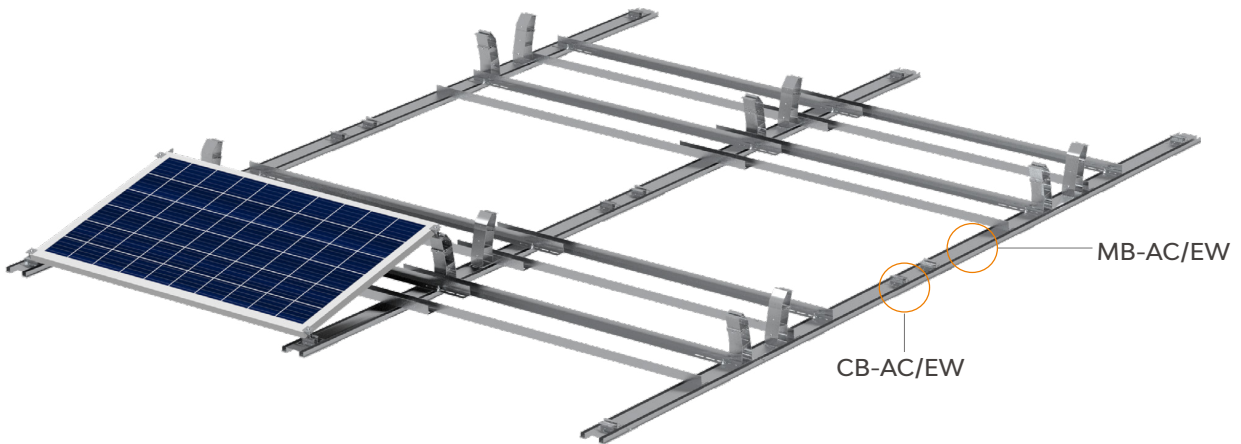





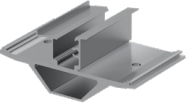
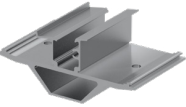

Ascent Wings

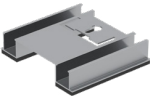

Available accessories

- Grounding/earthing
- Cable clips
- Rail caps

	<p>EC-M28-46/L50 End Clamp 28-46mm, with M module</p>	<ul style="list-style-type: none"> - Universal Clamp, Length 50mm, Anodised - M Module 16.5*30.7mm - Corrugated L-anchor Plate 3 - Button Head Torx Screws M8*35 - Lock washer 8 - Spring for Universal Clamp
	<p>IC-M28-46/L50 Inter Clamp 28-46mm, with M module</p>	<ul style="list-style-type: none"> - Universal Clamp, Length 50mm, Anodised - M Module 16.5*30.7mm - Button Head Torx Screws M8*35 - Lock washer 8 - Spring for Universal Clamp
	<p>FL-AC/10 Front Leg 10°</p>	<ul style="list-style-type: none"> - Front Leg 10°
	<p>FL-AC/15 Front Leg 15°</p>	<ul style="list-style-type: none"> - Front Leg 15°
	<p>RL-AC/10 Rear Leg 10°</p>	<ul style="list-style-type: none"> - Rear Leg 10°
	<p>RLE-AC Rear Leg Extension</p>	<ul style="list-style-type: none"> - Rear Leg Extension - Grounding Lug Bolt II
	<p>SEB-AC/120 Start and End Base L120</p>	<ul style="list-style-type: none"> - Start and End Base L120 - Rubber Pad, 120*30*5mm

	<p>MB-AC/SN Main Base L, South/north</p>	<ul style="list-style-type: none"> - Main Base L1500/L1800, South/north - Rubber Pad, 120*30*5mm
	<p>MB-AC/EW Main Base L, East- west</p>	<ul style="list-style-type: none"> - Main Base L2200, East- west - Rubber Pad, 120*30*5mm
	<p>CB-AC/EW Connection Base, East- west</p>	<ul style="list-style-type: none"> - Connection Base L250, East- west - Rubber Pad, 120*30*5mm
	<p>WD-AC/M Wind Deflector</p>	<ul style="list-style-type: none"> - Wind Deflector 10°/15°, L1920/L2230,MAC Steel - Flange Facing Self-Tapping Screw (washer) ST6.3*32
	<p>BB-AC-XXXXM Ballast Bar , MAC Steel</p>	<ul style="list-style-type: none"> - Ballast Bar-50.8*50.8*1920/2230, with 50mm slot hole - Hexagon nut with flange M8 - T-head bolt M8*25
	<p>LS-AC10/XL LS-AC15/XL Leg Support 10°, 15° for XL Panel</p>	<ul style="list-style-type: none"> - Upper Part of Front Leg Support 10° and 15° - Lower Part of Front Leg Support 10° and 15° - Lower Part of Rear Leg Support 10° and 15° - Upper Part of Rear Leg Support 10° and 15° - AC Fix Block 1 - AC Fix Block 2 - Universal Clamp for M Module 17*32.7mm - Rubber Pad 35*45 - Lock washer 8 - Spring for Universal Clamp - Hexagon socket button head screw M8*35 - Hexagon socket button head screw M8*20 - Washer 8 - Plain washer 8 - Cup head square neck bolts M8*20 - Hexagon nut with flange M8